

BRAKE PIPE FLARING TOOL

Patented design, for producing fast high quality flares 'on-the-vehicle' with ease. Unique hydraulic power unit provides ultimate power for precision flaring.

The ultimate flaring tool designed to save time, money and frustration, Will produce SAE or DIN, single or double laps flares on 4.75mm ,5mm.6mm pipe.

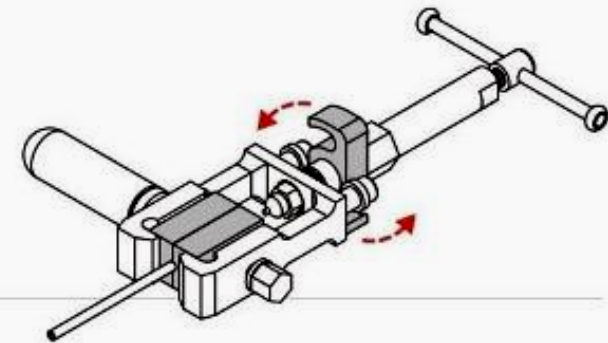
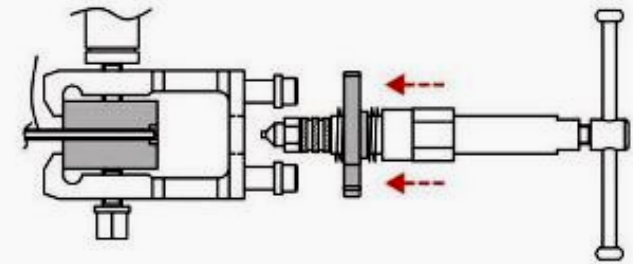

» FEATURES :

- Quick-Release Chuck for positive engagement of the punch.
- Patented fast-Turn **S** slider on hydraulic ram, for quick assembly.
- Precision casting yoke unit for great strength.
- Re-designed handle molding, for great comfort.

» EASY OPERATION :

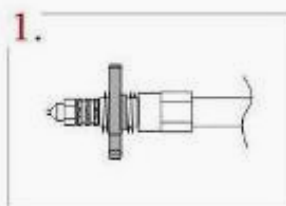

1. Select adapter and turn **S** slider to half screw.

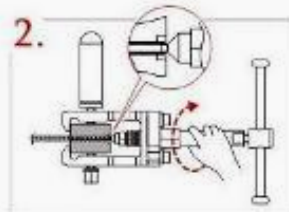

2. Let **S** slider match yoke than turn tie hydraulic gun. (Let adapter head put in pipe)

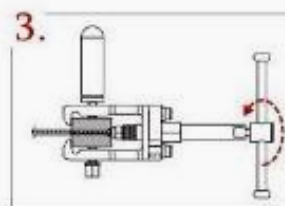

3. Turn T bar let it tie close.

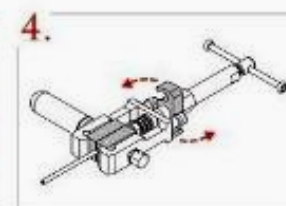

4. Return back T bar let **S** slider with yoke separate.

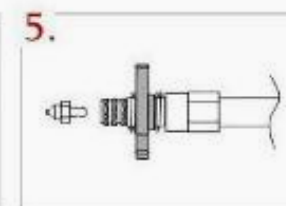

5. Change the adapter.

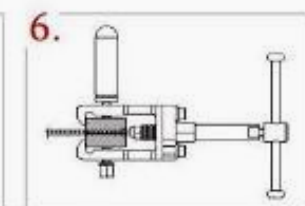

6. Let **S** slider match yoke turn T bar again.